

LOUVER Series

Privacy Type, Tear-Drop

(No Molding)

1-3/4" Doors

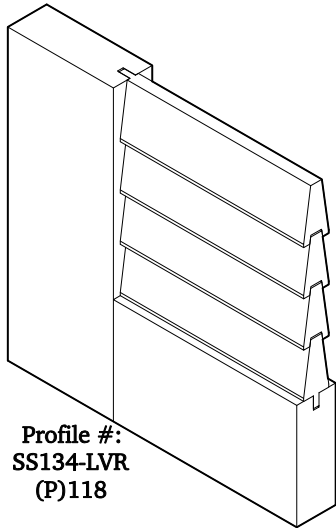

Profile #:
SS134-LVR
(P)118

1-3/8" Doors

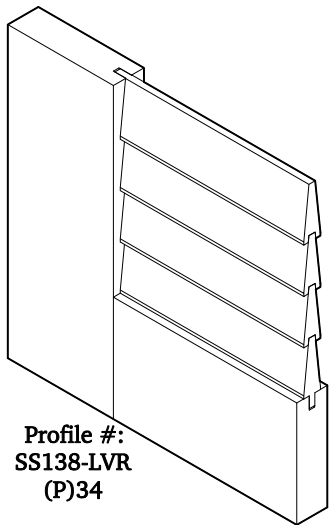

Profile #:
SS138-LVR
(P)34

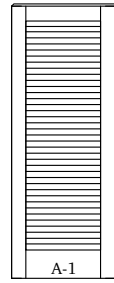

A-1
Full Length
Louver

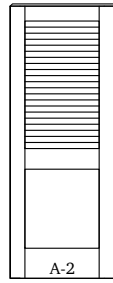

A-2
Top:Louwer
Btm:Panel

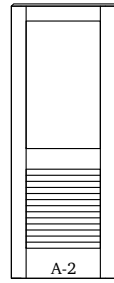

A-2
Top:panel
Btm:Louwer

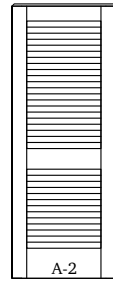

A-2
Top:Louwer
Btm:Louwer

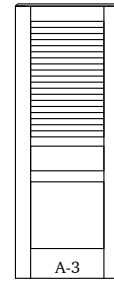

A-3
Top:Louwer
Mid&Btm:Panel

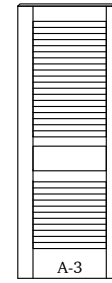

A-3
Top&Btm:Louwer
Mid:Panel

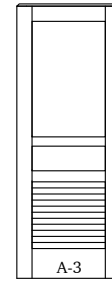

A-3
Top&Mid:Panel
Btm:Louwer

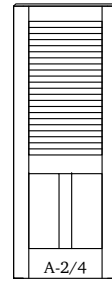

A-2/4
Top:Louwer
Btm:Panel

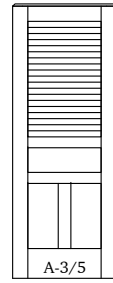

A-3/5
Top:Louwer
Mid&Btm:Panel

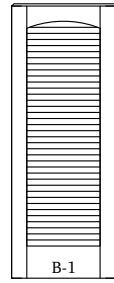

B-1
Full Length
Louver

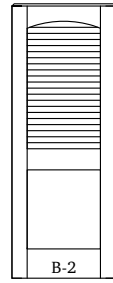

B-2
Top:Louwer
Btm:Panel

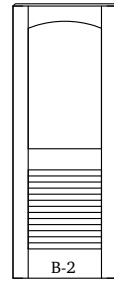

B-2
Top:Panel
Btm:Louwer

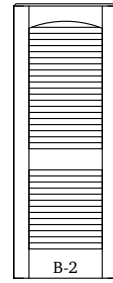

B-2
Top:Louwer
Btm:Louwer

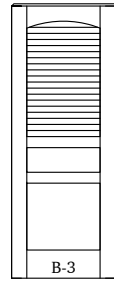

B-3
Top:Louwer
Mid&Btm:Panel

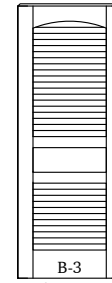

B-3
Top&Btm:Louwer
Mid:Panel

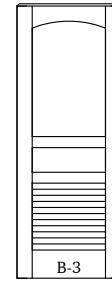

B-3
Top&Mid:Panel
Btm:Louwer

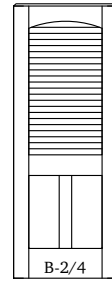

B-2/4
Top:Louwer
Btm:Panel

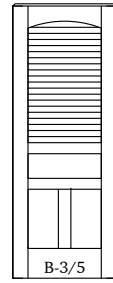

B-3/5
Top:Louwer
Mid&Btm:Panel

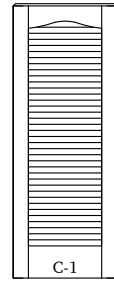

C-1
Full Length
Louver

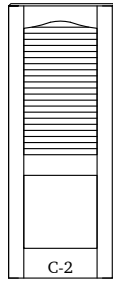

C-2
Top:Louwer
Btm:Panel

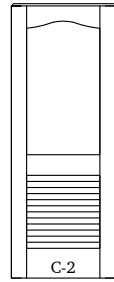

C-2
Top:panel
Btm:Louwer

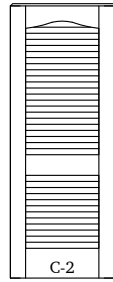

C-2
Top:Louwer
Btm:Louwer

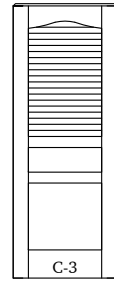

C-3
Top:Louwer
Mid&Btm:Panel

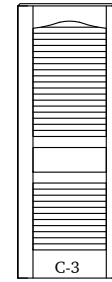

C-3
Top&Btm:Louwer
Mid:Panel

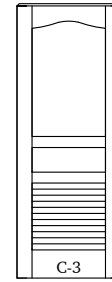

C-3
Top&Mid:Panel
Btm:Louwer

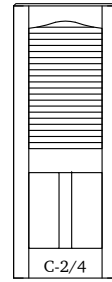

C-2/4
Top:Louwer
Btm:Panel

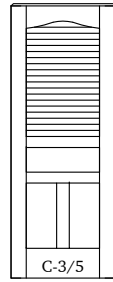

C-3/5
Top:Louwer
Mid&Btm:Panel

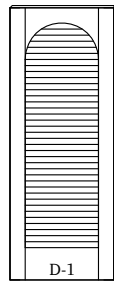

D-1
Full Length
Louver

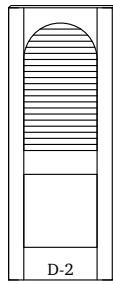

D-2
Top:Louwer
Btm:Panel

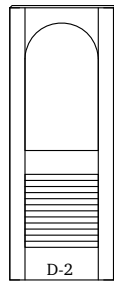

D-2
Top:Panel
Btm:Louwer

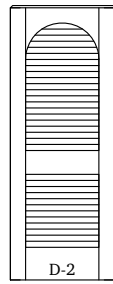

D-2
Top:Louwer
Btm:Louwer

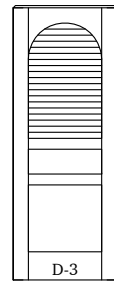

D-3
Top:Louwer
Mid&Btm:Panel

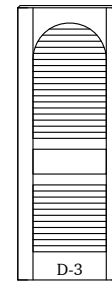

D-3
Top&Btm:Louwer
Mid:Panel

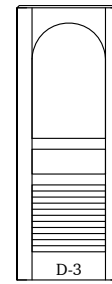

D-3
Top&Mid:Panel
Btm:Louwer

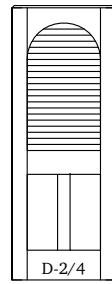

D-2/4
Top:Louwer
Btm:Panel

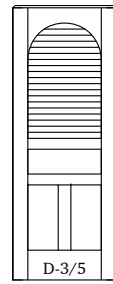

D-3/5
Top:Louwer
Mid&Btm:Panel

LOUVER Series

Privacy Type, Tear-Drop

(With Molding)

1-3/4" Doors

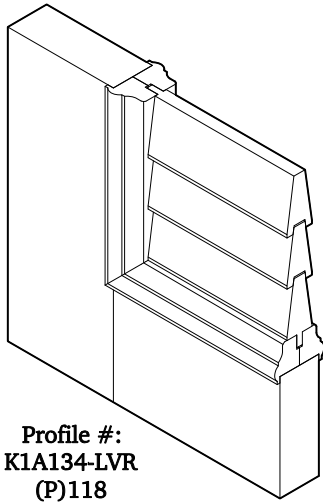

1-3/8" Doors

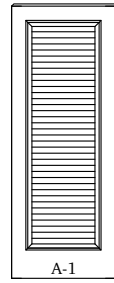
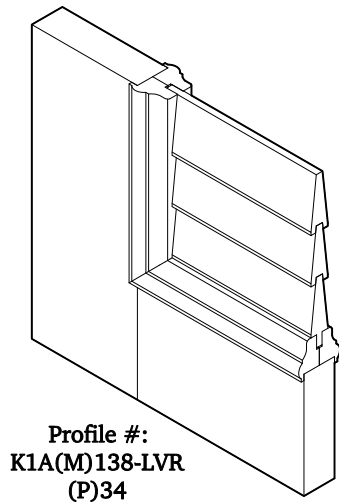

A-1
Full Length
Louver

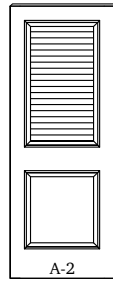

A-2
Top: Louver
Btm: Panel

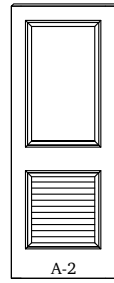

A-2
Top: panel
Btm: Louver

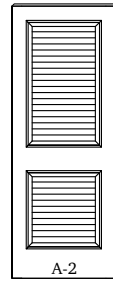

A-2
Top: Louver
Btm: Louver

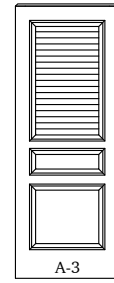

A-3
Top: Louver
Mid&Btm: Panel

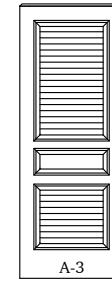

A-3
Top&Btm: Louver
Mid: Panel

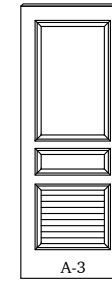

A-3
Top&Mid: Panel
Btm: Louver

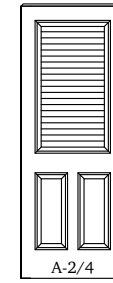

A-2/4
Top: Louver
Btm: Panel

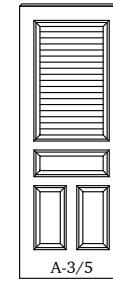

A-3/5
Top: Louver
Mid&Btm: Panel

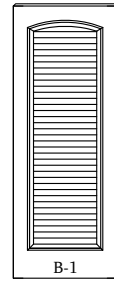

B-1
Full Length
Louver

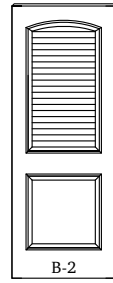

B-2
Top: Louver
Btm: Panel

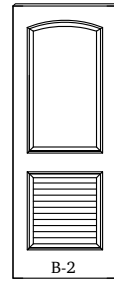

B-2
Top: Panel
Btm: Louver

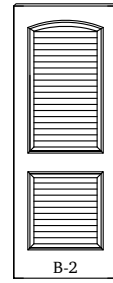

B-2
Top: Louver
Btm: Louver

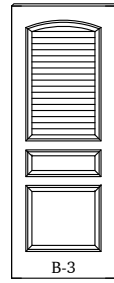

B-3
Top: Louver
Mid&Btm: Panel

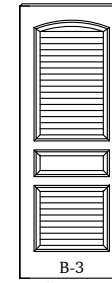

B-3
Top&Btm: Louver
Mid: Panel

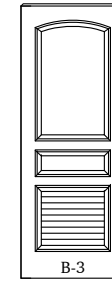

B-3
Top&Mid: Panel
Btm: Louver

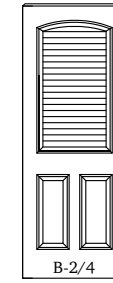

B-2/4
Top: Louver
Btm: Panel

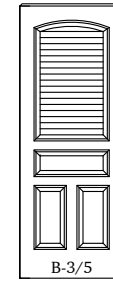

B-3/5
Top: Louver
Mid&Btm: Panel

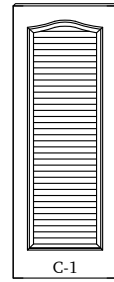

C-1
Full Length
Louver

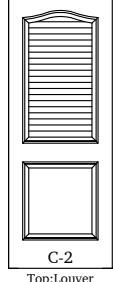

C-2
Top: Louver
Btm: Panel

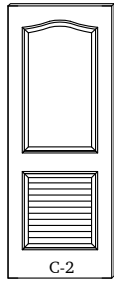

C-2
Top: panel
Btm: Louver

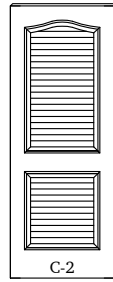

C-2
Top: Louver
Btm: Louver

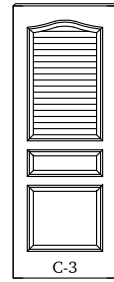

C-3
Top: Louver
Mid&Btm: Panel

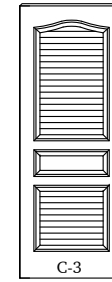

C-3
Top&Btm: Louver
Mid: Panel

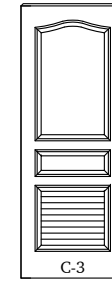

C-3
Top&Mid: Panel
Btm: Louver

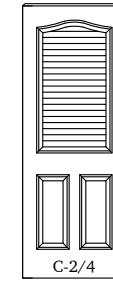

C-2/4
Top: Louver
Btm: Panel

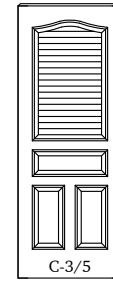

C-3/5
Top: Louver
Mid&Btm: Panel

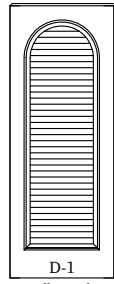

D-1
Full Length
Louver

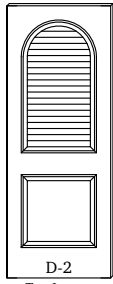

D-2
Top: Louver
Btm: Panel

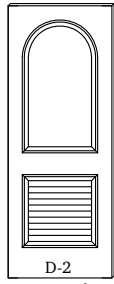

D-2
Top: Panel
Btm: Louver

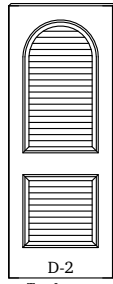

D-2
Top: Louver
Btm: Louver

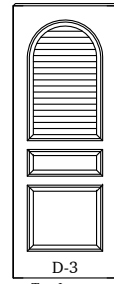

D-3
Top: Louver
Mid&Btm: Panel

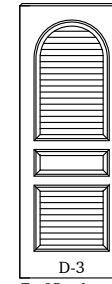

D-3
Top&Btm: Louver
Mid: Panel

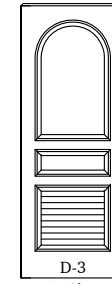

D-3
Top&Mid: Panel
Btm: Louver

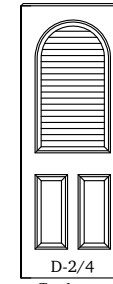

D-2/4
Top: Louver
Btm: Panel

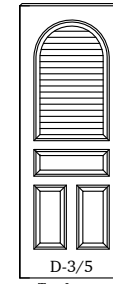

D-3/5
Top: Louver
Mid&Btm: Panel